



M Series™ Corner Installation Guide

NAILITE

1111 NW 165th Street, Miami, Florida 33169-5819
Toll Free: 888-300-0070 • Fax: 305-623-8227

www.nailite.com

Mansard Application

Mansards with a minimum slope of 45/12 are acceptable for this application. Basic guidelines for Hand-Split Shake panels are included in each panel carton. Note: to allow individual adjustment do not stack corners prior to panel installation. Follow steps 1-4 for proper M Series Corner installation in mansard applications.

Step 1: Working from the bottom up, and left to right, install the first M Series Corner at its lowest point approximately 1" below the bottom edge of the starter strip.

Step 2: Take a second corner and insert the locking post from the lower corner into the receiving hole, then position it above the already installed corner. (Fig. #1)

Step 3: Slide your first angled pre-cut panel left, (Fig. #2) into the receiving channel of the corner pieces and align the panel cut edge with the insertion mark on the corner. (Fig. #4) Adjust the height of your second corner piece with the middle butt line of the panel. Since it is not possible to exactly match the two shakes that will meet at the corner, compensate by finding an approximate location between the two. Adjustment may be made up to 1" of travel. Slide panel slightly to the right and attach the corner. (Fig. #3)

Step 4: Slide panel back to the left and take a third corner piece and place over the second corner piece. Do not fasten this corner at this time. Now fasten your panel using nails or fasteners. (Fig. #3)

Helpful hint: If desired, the exposed bottom of the lowest corner may be capped using a flat portion of the Hand-Split Shake panel. Use the template provided below to cut a small piece to fit the corner. The piece may be attached using a pop rivet or small screw.

Fig. 1

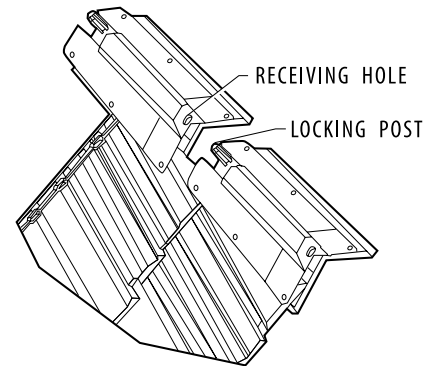

Fig. 2

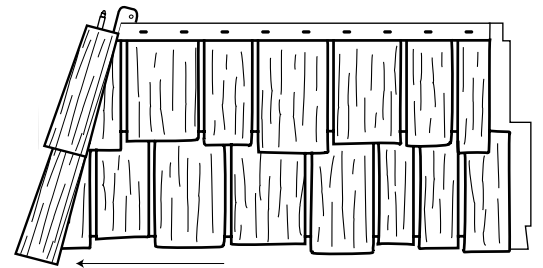

Fig. 3

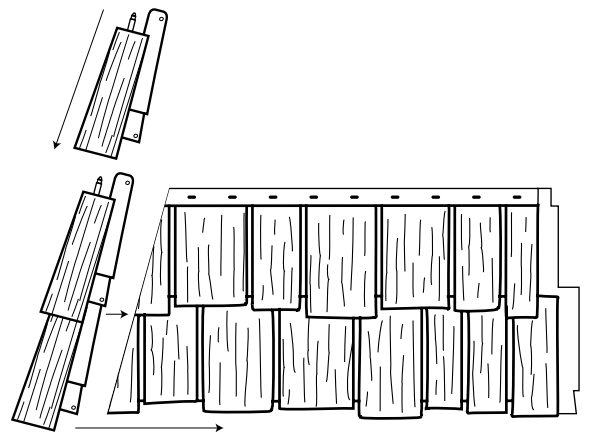
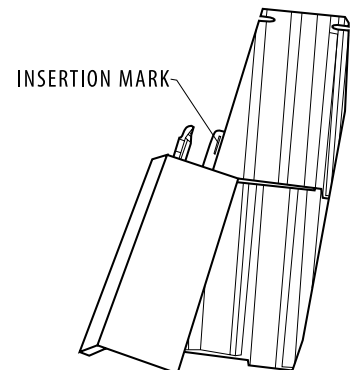

Fig. 4



Version MS-IG-0306

Nailite provides these instructions as installation guidelines. Nailite, however, neither installs the panels nor has any control over the installation. It is the responsibility of the contractor and/or the installer to ensure Nailite siding panels are installed in accordance with these instructions and any applicable building codes. Nailite assumes no liability for either improper installation or personal injury resulting from improper use or installation. Nailite meets or exceeds the guidelines set forth by NES. See NES Report# NER-580.



M Series™ Corner Installation Guide

NAILITE

1111 NW 165th Street, Miami, Florida 33169-5819
Toll Free: 888-300-0070 • Fax: 305-623-8227

www.nailite.com

Siding Application (Vertical)

Basic guidelines for Hand-Split Shake panels are included in each panel carton. Note: to allow individual adjustment do not stack corners prior to panel installation.

Step 1: Working from the bottom up, and left to right, install the first M Series Corner approximately 1" below the bottom edge of the starter strip.

Step 2: Take a second corner and position it above the already installed corner. (Fig. #6)

Step 3: Slide your first pre-cut panel left, into the receiving channel of the corner pieces and align the panel edge with the insertion mark on the corner (Fig. #5). Adjust the height of your second corner piece with the middle butt line of the panel (Fig. #7). Since it is not possible to exactly match the two shakes that will meet at the corner, compensate by finding an approximate location between the two. Adjustment may be made up to 1" of travel. Slide panel slightly to the right and attach the corner.

Step 4: Slide panel back to the left (Fig. #7) and take a third corner piece and place over the second corner piece (Fig. #8). Do not fasten this corner at this time. Now fasten your panel using nails or fasteners.

Helpful hint: If desired, the exposed bottom of the lowest corner may be capped using a flat portion of the Hand-Split Shake panel. Use the template provided below to cut a small piece to fit the corner. The piece may be attached using a pop rivet or small screw.

Fig. 5

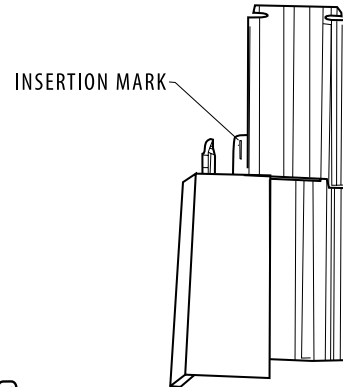

Fig. 6

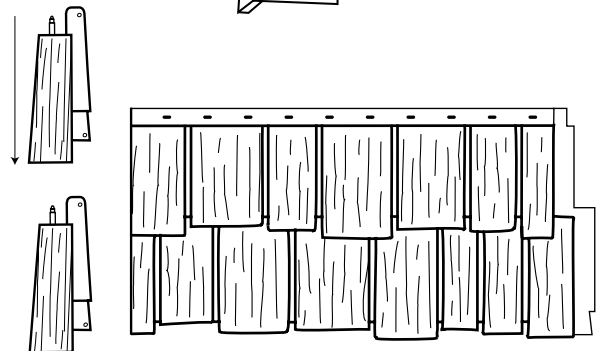

Fig. 7

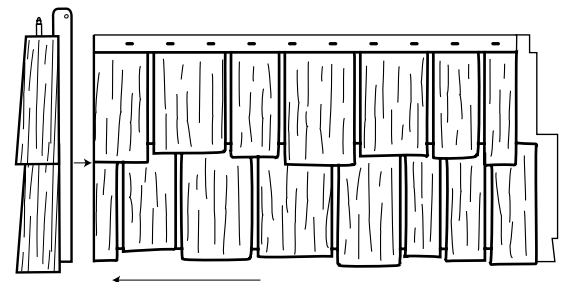
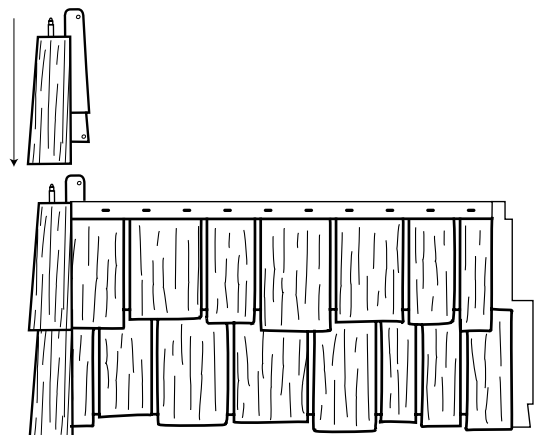

Fig. 8



Version MS-IG-0306

Nailite provides these instructions as installation guidelines. Nailite, however, neither installs the panels nor has any control over the installation. It is the responsibility of the contractor and/or the installer to ensure Nailite siding panels are installed in accordance with these instructions and any applicable building codes. Nailite assumes no liability for either improper installation or personal injury resulting from improper use or installation. Nailite meets or exceeds the guidelines set forth by NES. See NES Report# NER-580.



M Series™ Corner Installation Guide

N A I L I T E

1111 NW 165th Street, Miami, Florida 33169-5819
Toll Free: 888-300-0070 • Fax: 305-623-8227

www.nailite.com

✂ Template for corner cap ✂

